

LEDJ

Spectra Par 7T3 Exterior Fixture

User Manual



Order code: LEDJ257

WARNING**FOR YOUR OWN SAFETY, PLEASE READ THIS USER MANUAL CAREFULLY BEFORE YOUR INITIAL START-UP!**

- Before your initial start-up, please make sure that there is no damage caused during transportation.
- Should there be any damage, consult your dealer and do not use the equipment.
- To maintain the equipment in good working condition and to ensure safe operation, it is necessary for the user to follow the safety instructions and warning notes written in this manual.
- Please note that damages caused by user modifications to this equipment are not subject to warranty.

**IMPORTANT:**

The manufacturer will not accept liability for any resulting damages caused by the non-observance of this manual or any unauthorised modification to the equipment.

- Never let the power cable come into contact with other cables. Handle the power cable and all mains voltage connections with particular caution!
- Never remove warning or informative labels from the unit.
- Do not open the equipment and do not modify the unit.
- Do not connect this equipment to a dimmer pack.
- Do not switch the equipment on and off in short intervals, as this will reduce the system's life.
- Do not expose to flammable sources, liquids or gases.
- Always disconnect the power from the mains when equipment is not in use or before cleaning! Only handle the power-cable by the plug. Never pull out the plug by pulling the power-cable.
- Make sure that the available mains supply voltage is between 100~240V AC, 50/60Hz.
- Make sure that the power cable is never crimped or damaged. Check the equipment and the power cable periodically.
- If the equipment is dropped or damaged, disconnect the mains power supply immediately and have a qualified engineer inspect the equipment before operating again.
- If your product fails to function correctly, stop use immediately. Pack the unit securely (preferably in the original packing material), and return it to your Pro Light dealer for service.
- Only use fuses of same type and rating.
- Repairs, servicing and power connection must only be carried out by a qualified technician. **THIS UNIT CONTAINS NO USER SERVICEABLE PARTS.**
- This lighting fixture is for professional use only - it is not designed for or suitable for household use. The product must be installed by a qualified technician in accordance with local territory regulations. The safety of the installation is the responsibility of the installer. The fixture presents risks of severe injury or death due to fire hazards, electric shock and falls.
- Warning! Risk Group 2 LED product according to EN 62471. Do not view the light output with optical instruments or any device that may concentrate the beam.
- **WARRANTY:** One year from date of purchase.

OPERATING DETERMINATIONS

If this equipment is operated in any other way, than those described in this manual, the product may suffer damage and the warranty becomes void. Incorrect operation may lead to danger e.g: short-circuit, burns and electric shocks etc.

Do not endanger your own safety and the safety of others!

Incorrect installation or use can cause serious damage to people and/or property.

Spectra Par 7T3 Exterior Fixture



The LEDJ Spectra Par 7T3 features a stylish and compact design. The fixture is suitable for architectural and stage lighting and can be used for both interior and exterior applications (IP66 rated). The housing is made of aluminium alloy and is gasket sealed. The unit is equipped with 7 x 3W tri-colour RGB LEDs and controlled via DMX or the optional IR remote control.

- 7 x 3W tri-colour LEDs (RGB)
- Beam angle: 28°
- 1,155 Lux @ 2m (full on)
- Refresh rate: 7.8kHz
- DMX channels: 1/3/4/5 or 6 selectable
- Static colour, colour fade, colour change, auto and master/slave modes
- 0 - 100% dimming
- Variable strobe
- Bracket allows for multiple rigging or floor standing applications
- 4 button menu with LED display
- Hydralock power input/output
- linkable trailing connections (35cm)
- Hydralock DMX input/output linkable trailing connections (35cm)
- Convection cooled
- Optional IR remote (LEDJ90A)

Specifications	Spectra Par 7T3
Power consumption	35W
Power supply	100~240V, 50/60Hz
Dimensions	180 x 156 x 125
Weight	1.6kg
Order code	LEDJ257

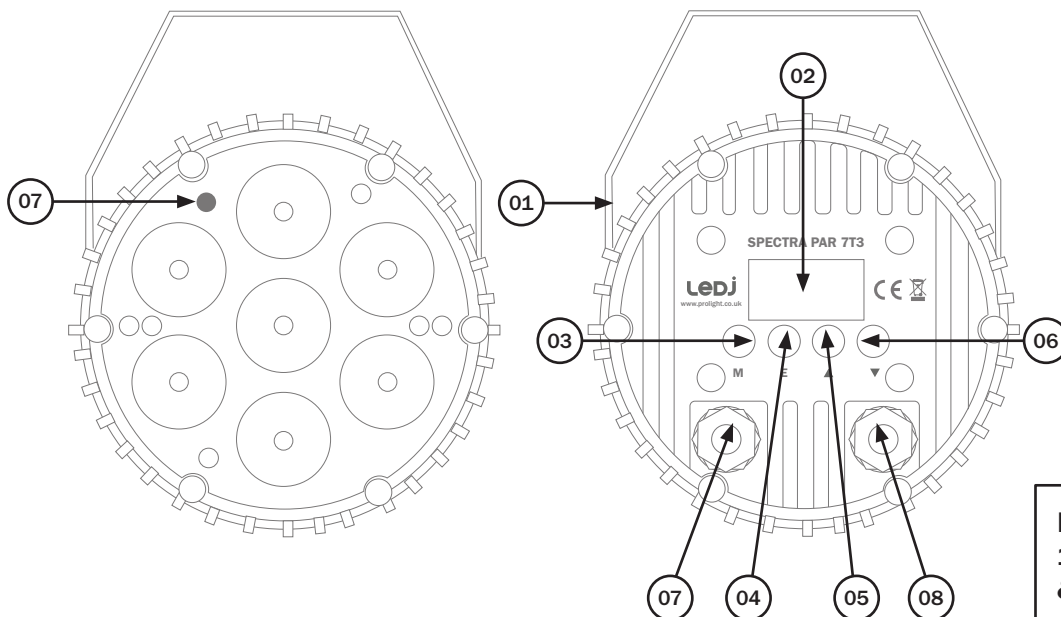
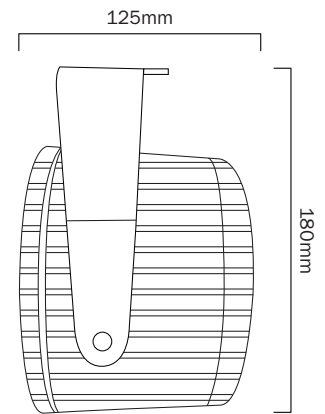
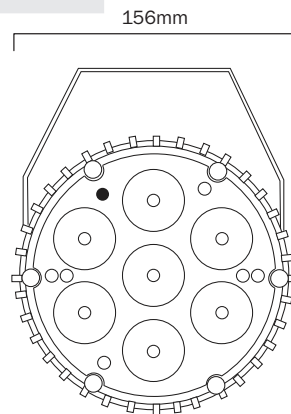
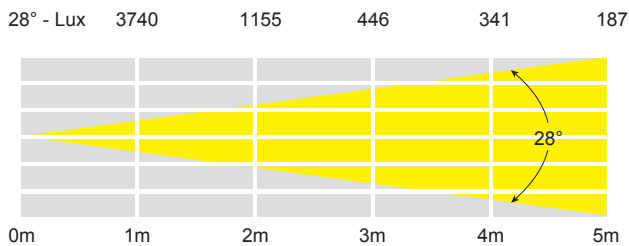

- 01 - Hanging bracket
- 02 - LED display
- 03 - Menu button
- 04 - Enter button
- 05 - Up button
- 06 - Down button
- 07 - IP rated power input/output
- 08 - IP rated DMX power input/output
- 09 - IR receiver

In the box:
1 x fixture, 1 x power cable & 1 x user manual

DMX mode:

To select the DMX address, press the “M” button on the rear of the unit to show *000 1* on the LED display. Now use the “UP” and “DOWN” buttons to select the DMX address between 001-512.

To exit out of any of the above options, press the “M” button.

DMX channel mode:

Operating in a DMX control mode environment gives the user the greatest flexibility when it comes to customising or creating a show. In this mode you will be able to control each individual trait of the fixture and each fixture independently. To access the DMX channel mode, press the “M” button on the rear of the unit to show *000 1* on the LED display. Now press the “E” button to show *-- CH* on the LED display and use the “UP” and “DOWN” buttons to select between 1, 3, 4, 5 and 6 channels.

To exit out of any of the above options, press the “M” button.

1 channel mode:

Channel	Value	Function
1	000	No function
	001-022	Red
	023-045	Green
	046-068	Blue
	069-091	Cyan
	092-114	Yellow
	115-137	Orange
	138-160	Pink
	161-183	Purple
	184-206	Dark Blue
	207-229	Pale Green
	230-252	White
	253-255	Warm White

3 channel mode:

Channel	Value	Function
1	000-255	Red (0-100%)
2	000-255	Green (0-100%)
3	000-255	Blue (0-100%)

4 channel mode:

Channel	Value	Function
1	000-255	Red (0-100%)
2	000-255	Green (0-100%)
3	000-255	Blue (0-100%)
4	000-255	Master dimmer (0-100%)

5 channel mode:

Channel	Value	Function
1	000-255	Red (0-100%)
2	000-255	Green (0-100%)
3	000-255	Blue (0-100%)
4	000-255	Master dimmer (0-100%)
5	000-255	Strobe (slow-fast)

6 channel mode:

Channel	Value	Function
1	000-255	Master dimmer (0-100%)
2	000-255	Red (0-100%) (only when channel 6 is set to 0)
	000-008	Red
	009-017	Orange
	018-026	Yellow
	027-035	Spring Yellow
	036-044	Lime
	045-053	Light Yellow
	054-062	Light Green
	063-071	Green
	072-080	Pastel Green
	081-089	Light Cyan
	090-098	Cyan
	099-107	Light Blue
	108-116	Medium Blue
	117-125	Blue
	126-134	Violet
	135-143	Purple
	144-152	Magenta
	153-161	Pink
	162-170	Light Pink
	171-179	Pastel Blue
	180-188	Pastel Green
	189-197	Pastel Yellow
	198-206	Pastel Purple
	207-215	Pastel Cyan
	216-224	Turquoise
225-233	Pastel Pink	
234-242	Neutral White	
243-251	Warm White	
252-255	Cool White	

To use static colours channel 6 should be set between 001-025

Channel 2 is used as program speed (0-255 slow-fast) when channel 6 is set between 026-255

3	000-255	Green (0-100%)	
4	000-255	Blue (0-100%)	
5	000-009	No function	
	010-255	Strobe (slow-fast)	
6	000-025	Static colours	Use channel 2 for colour selection
	026-051	7 colour fade in/out	Use channel 2 for program speed (0-255 slow-fast)
	052-077	3 colour fade in/out	
	078-103	7 colour change	
	104-129	3 colour change	
	130-155	7 colour fade	
	156-181	3 colour fade	
	182-207	Red fade in/out	
	208-233	Green fade in/out	
	234-255	Blue fade in/out	

Static colour mode:

To access the static colour mode press “M” until *Color* shows on the LED display. Now press the “E” button and use the “UP” and “DOWN” buttons to select the brightness between *r.000 ~ r.255*. Press the “E” button and repeat for green (*g*) and blue (*b*).

Value: 000 - 255 (000 = low brightness, 255 = high brightness)

To exit out of any of the above options, press the “M” button.

Built-in programs:

To access the built-in programs, press the “M” button on the front of the unit to show *Pr - -* on the LED display. Now use the “UP” and “DOWN” buttons to choose the required program *Pr 0 1 ~ Pr 0 7*. Press the “E” button to confirm the setting and use the “UP” and “DOWN” buttons to choose the speed *SP00 ~ SP99*. Press the “E” button again to confirm the setting and use the “UP” and “DOWN” buttons to select the flash speed *F500 ~ F599*.

Pr 0 1 - Press the “E” button and use the “UP” and “DOWN” buttons to select the static colour required. Press the “E” button to confirm the setting and use the “UP” and “DOWN” buttons to select the flash speed *F500 ~ F599*.

To exit out of any of the above options, press the “M” button.

<i>0</i> - White (RGB)	<i>3</i> - Light Yellow	<i>6</i> - Blue	<i>9</i> - Yellow
<i>1</i> - Red	<i>4</i> - Green	<i>7</i> - Purple	<i>10</i> - Cool White
<i>2</i> - Orange	<i>5</i> - Cyan	<i>8</i> - Pink	<i>11</i> - Warm White

Auto mode:

To access auto mode, press the “M” button on the front of the unit to show *Auto* on the LED display. The unit will now run through its built-in programs.

To exit out of any of the above options, press the “M” button.

Master/slave mode:

The default setting for this fixture is Master.

To set the slave unit, press the “M” button on the front of the master unit to show *SLAVE* on the LED display.

The unit is now in Slave mode.

To exit out of any of the above options, press the “M” button.

Restore factory settings:

To restore the unit back to its factory settings, press the “M” and “E” buttons simultaneously.

Menu system

Static colour mode	<i>r.000~r.255 R</i> <i>g.000~g.255 G</i> <i>b.000~b.255 B</i>
Built-in programs	<i>Pr 0 1~Pr 0 7</i>
Auto mode	<i>Auto</i>
Master/slave mode	<i>SLAVE</i>
DMX mode	1CH, 3CH, 4CH, 5CH, 6CH
Address setting	<i>d00 1~d5 12</i>

Optional IR remote functions:

Button functions:

- 01 - Sets the LEDs into power on or off modes
- 02 - Runs the built-in programs, use the '+' and '-' buttons to go through the programs
- 03 - Runs the auto mode
- 04 - Sets the LEDs to flash on and off, use the '+' and '-' buttons to change the flash frequency
- 05 - Sets the run speed, use the '+' and '-' buttons to change the desired speed (note: only available in the colour change or colour fade modes)
- 06 - Sets the LEDs into DMX mode
- 07 - Sets the LEDs into sound active mode (this function is unavailable on this fixture)
- 08 - Sets the LEDs into slave mode
- 09 - Sets the DMX address for the LEDs
- 10 - Sets the LEDs colour, then use the '+' and '-' buttons to change the brightness

DMX address examples:

To set the DMX address "245";

- Press the "S" button, the red LEDs will come on, you can now start to set the DMX address
- Now press the "2" button, the green LEDs will come on, this means the first digit has been set at 2
- Now press the "4" button, the blue LEDs will come on, this means the second digit has been set at 4
- Now press the "5" button, and all the LEDs will come on, the third digit 5 has been set. The full DMX address setting has been changed
- Now press the "DMX MODE" button to save the new address into the memory

Important notes:

- Set the DMX address on each fixture before plugging into the DMX controller
- The IR remote cannot be used when the fixture(s) are being controlled with a DMX controller
- The maximum IR transmitter distance is 10m - Please make sure that you have the IR remote aimed directly at the front panel of each fixture to be programmed
- If you do not press the "DMX MODE" button after you have changed the DMX address when you power down the fixture it will lose the address you have set

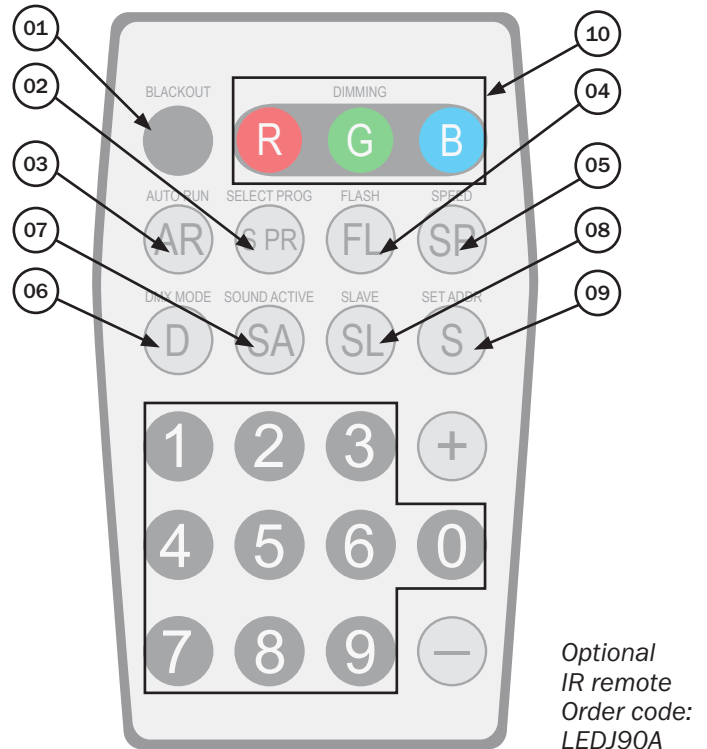

To set the DMX address "002";

- Press the "S" button, the red LEDs will come on, you can now start to set the DMX address
- Now press the "0" button, the green LEDs will come on, this means the first digit has been set at 0
- Now press the "0" button, the blue LEDs will come on, this means the second digit has been set at 0
- Now press the "2" button, and all the LEDs will come on, the third digit 5 has been set. The full DMX address setting has been changed
- Now press the "DMX MODE" button to save the new address into memory

Setting the DMX address:

The DMX mode enables the use of a universal DMX controller. Each fixture requires a “start address” from 1- 512. A fixture requiring one or more channels for control begins to read the data on the channel indicated by the start address. For example, a fixture that occupies or uses 7 channels of DMX and was addressed to start on DMX channel 100, would read data from channels: 100,101,102,103,104,105 and 106. Choose a start address so that the channels used do not overlap. E.g. the next unit in the chain starts at 107.

DMX 512:

DMX (Digital Multiplex) is a universal protocol used as a form of communication between intelligent fixtures and controllers. A DMX controller sends DMX data instructions from the controller to the fixture. DMX data is sent as serial data that travels from fixture to fixture via the DATA “IN” and DATA “OUT” XLR terminals located on all DMX fixtures (most controllers only have a data “out” terminal).

DMX linking:

DMX is a language allowing all makes and models of different manufactures to be linked together and operate from a single controller, as long as all fixtures and the controller are DMX compliant. To ensure proper DMX data transmission, when using several DMX fixtures try to use the shortest cable path possible. The order in which fixtures are connected in a DMX line does not influence the DMX addressing. For example; a fixture assigned to a DMX address of 1 may be placed anywhere in a DMX line, at the beginning, at the end, or anywhere in the middle. When a fixture is assigned a DMX address of 1, the DMX controller knows to send DATA assigned to address 1 to that unit, no matter where it is located in the DMX chain.

Also remember that DMX cable must be daisy chained and cannot be split.

DATA cable (DMX cable) requirements (for DMX operation):

This fixture can be controlled via DMX-512 protocol. The DMX address is set on the back of the unit.

Further DMX cables can be purchased from all good sound and lighting suppliers or Prolight Concepts dealers. Please quote:

LEDJ 1m Interior - Exterior DMX cable	LEDJ 1m Exterior DMX cable	LEDJ 2m Exterior DMX cable	LEDJ 5m Exterior DMX cable	LEDJ 10m Exterior DMX cable
				
Order code: LEDJ91	Order code: LEDJ141	Order code: LEDJ142	Order code: LEDJ143	Order code: LEDJ144

LEDJ 1m Exterior Power cable	LEDJ 2m Exterior Power cable	LEDJ 5m Exterior Power cable	LEDJ 10m Exterior Power cable	LEDJ Spectra Series End Cap Set
				
Order code: LEDJ146	Order code: LEDJ147	Order code: LEDJ148	Order code: LEDJ149	Order code: LEDJ93

Notice:

Be sure to follow the diagrams below when making your own cables. Do not connect the cables shield conductor to the ground lug or allow the shield conductor to come in contact with the XLRs outer casing. Grounding the shield could cause a short circuit and erratic behaviour.

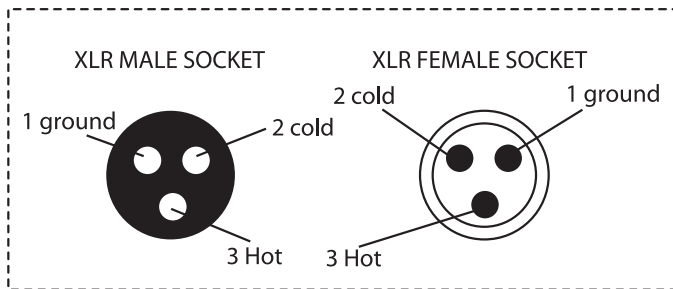
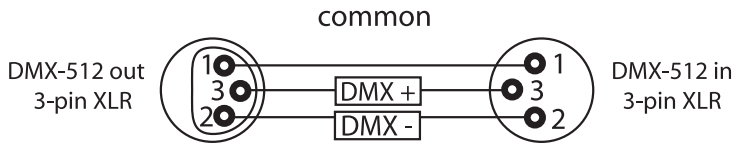

XLR Pin Configuration
Pin 1 = Ground
Pin 2 = Negative
Pin 3 = Postive

Special note:

Line termination:

When longer runs of cable are used, you may need to use a terminator on the last unit to avoid erratic behaviour.

Using a cable terminator will decrease the possibilities of erratic behaviour.

(3-pin - Order ref: CABL90, 5-pin - Order ref: CABL89)

Termination reduces signal transmission problems and interference. It is always advisable to connect a DMX terminal, (resistance 120 Ohm 1/4 W) between pin 2 (DMX-) and pin 3 (DMX+) of the last fixture.

5-pin XLR DMX connectors:

Some manufactures use 5-pin XLR connectors for data transmission in place of 3-pin. 5-pin XLR fixtures may be implemented in a 3-pin XLR DMX line. When inserting standard 5-pin XLR connectors in to a 3-pin line a cable adaptor must be used. The diagram below details the correct cable conversion.

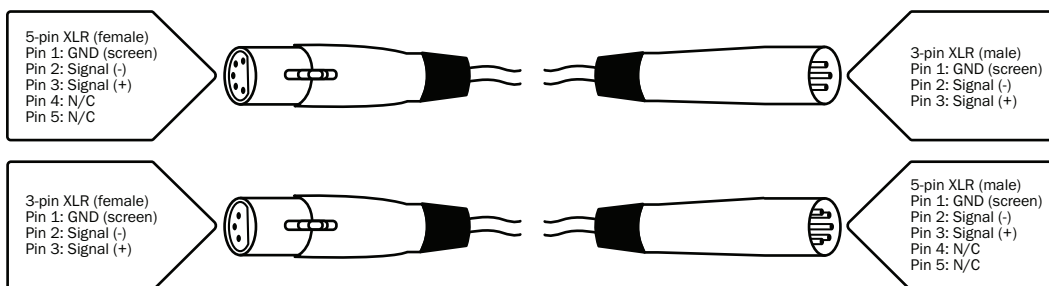



***Correct Disposal of this Product
(Waste Electrical & Electronic Equipment)***

**(Applicable in the European Union and other European countries
with separate collection systems)**

This marking shown on the product or its literature, indicates that it should not be disposed of with other household wastes at the end of its working life. To prevent possible harm to the environment or human health from uncontrolled waste disposal, please separate this from other types of wastes and recycle it responsibly to promote the sustainable reuse of material resources.

Household users should contact either the retailer where they purchased this product, or their local government office, for details of where and how they can take this item for environmentally safe recycling.

Business users should contact their supplier and check the terms and conditions of the purchase contract. This product should not be mixed with other commercial wastes for disposal.



LEDj